

1 SCAN

SCAN QR CODE
and download
GUIDES' MASKS

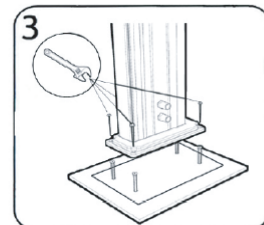
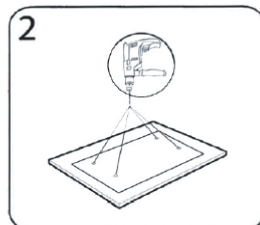
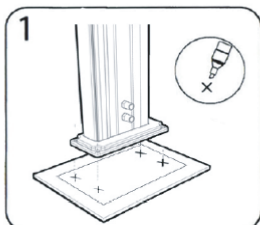

Fissare le viti in prossimità dei fori e avvitare i collegamenti idrici /
Fix the screws near the holes and screw the water connections

2 FISSAGGIO / FIXING

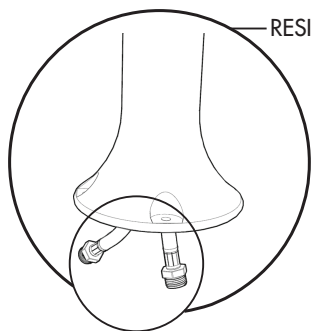

RESINA / RESIN

-Raccordo blu / Blue pipe
Acqua fredda / Cold water

-Raccordo rosso / Red pipe
Acqua calda / hot water

— ALLUMINIO / ALLUMINIUM

-Raccordo blu / Blue pipe
Acqua fredda / Cold water

-Raccordo rosso / Red pipe
Acqua calda / Hot water

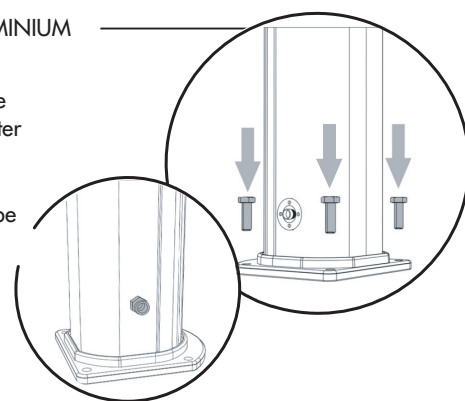

3 ALLACCIO / WATER CONNECTION

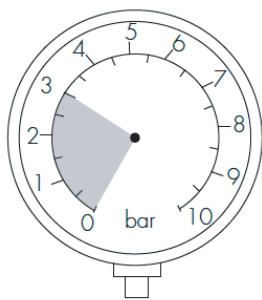

Pressione dell'acqua MAX 3 bar /
Water pressure MAX 3 bar

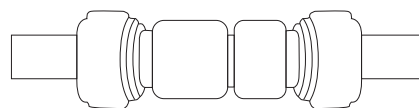

Acqua fredda / Cold water

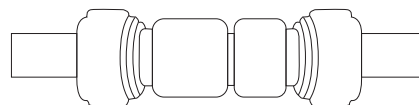

Acqua calda / hot water

Innesto rapido da giardino /
Quick connection for the garden

4 PRONTA ALL'USO / READY TO USE

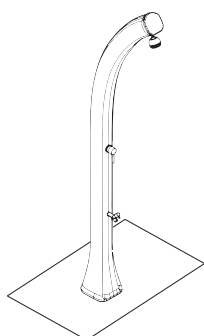

Verificare che la doccia sia ben fissata a terra e che i tubi siano collegati correttamente.
Check that the shower is firmly grounded and that the pipes are connected correctly.

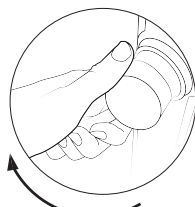

OPEN

Pronta all'uso. Ready to use.

NOTE: Installazione da effettuare a cura di personale qualificato
NOTES: Installation to be carried out by qualified personnel

CHIUSURA INVERNALE / WINTER CLOSURE

1 SCARICO ACQUA / WATER DISCHARGE

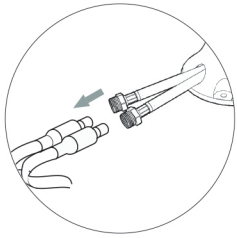

Staccare i
tubi di
collega-
mento
idrico

Disconnect
the water
connection
pipe

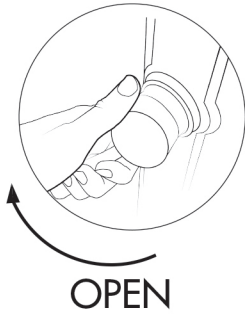

Aprire il
mixer
dell'acqua

Open the
water
mixer



Aspettare che
la doccia sia
completamente
svuotata

Wait for the
shower to
empty
completely

OPEN

2 COPRIRE LA DOCCIA / COVER THE SHOWER

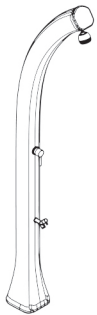

+



=



3 MODELLI / MODELS

Queste istruzioni sono valide per i seguenti modelli tradizionali:
These instructions are valid for the following traditional models:

Le nostre colonne doccia, avendo una portata inferiore a 9 L/m, soddisfano i requisiti per ottenere i bonus ministeriali già attivi ed in fase di attivazione per il 2021.
Per maggiori informazioni consultare il manuale d'installazione a pag. 7



RESINA / RESIN



FUNNY YIN



FUNNY YANG



SPRING PLUS



H2O

ALLUMINIO / ALUMINIUM



JOLLY



JOLLY S



SPRING



SPRING S



DADA



DADA S



GARDEN SURPRISE



JOLLY GO



JOLLY LAVAPIEDI



JOLLY FONTANA

ATTENZIONE: Al fine di garantire una corretta assistenza non perdere il codice identificativo della doccia posto sulla scatola interna.

ATTENTION: In order to guarantee correct assistance, do not lose the identification code of the shower located on the internal box